

# Burner Controls for continuously operating Burners

**LOK16...  
LGK16...  
Series ...A...**

(with self-checking flame signal amplifier)



ISO 9001



Supplementary data sheets 7712 and 7713

**Burner controls for continuously operating multi-stage or modulating burners of medium to high capacity; with air pressure supervision for checked air damper control.**

**The gas burner controls are tested to EN298 and CE certified in compliance with the directives for gas-fired appliances and electromagnetic compatibility.**

**The oil burner controls are tested to EN230 and CE marked in compliance with the directives for electromagnetic compatibility.**

## Use

The burner controls LOK16... and LGK16... feature a self-checking flame supervision circuit. This circuit initiates the required safety actions not only in the case of premature or missing flame signals, but also in the case of any kind of failure on the flame detector, the detector cables or the flame signal amplifier that might simulate a flame signal **during burner operation**. These burner controls are therefore suited for all types of oil- or gas-fired combustion plant where the use of self-checking flame supervision systems is either mandatory or advisable:

- Burners in continuous operation
- Burners in intermittent operation that, in the case of great heat demand, might however operate continuously for more than 24 hours, e.g. in plants using boiler sequencing
- Burners that need to comply with the German specifications TRD411 and TRD412 for steam boilers
- Burners in plants where, for specific safety requirements, supervision of the burner by a self-checking flame supervision system seems advisable
- The control program and the connection circuitry of these burner controls are **identical** to those of the LAL2... and LFL1... respectively (with the exception of LFL1.148) so that existing plants can also be equipped with self-checking burner controls
  - provided very good detector current values were measured in the plant supervised so far by LFL1..., and
  - provided the following flame detectors are either already installed or can subsequently be fitted:

### LOK16...

- Selenium photocell detector RAR...

### LGK16...

- UV detector QRA5..., designed specifically for use with LGK16...
- Ionization current detector electrode
- UV detector QRA5... together with ionization current detector electrode, e.g. for burners with pilot burner

## Mechanical design

The burner controls are of plug-in design. Housing and plug-in baseplate are made of shock- and heat-resistant black plastic.

The lockout indicator, fault signal lamp and reset button are located in the unit's viewing window. The burner control has an exchangeable unit fuse and a spare fuse.

## Operation

Prerequisites for burner start-up

- Burner control is reset and in the start position (terminals 11 and 12 under voltage)
- Air damper is closed. Limit switch «z» for the CLOSED position must feed voltage from terminal 11 to terminal 8
- All control contacts between terminals 12 and 5 (limit thermostat, control thermostat, etc.) must be closed

**A**

### Start

When «R» closes, the burner control's sequence switch starts running. At the same time, the fan motor connected to terminal 6 (only pre-purging) receives voltage and, on completion of «t7», the fan motor or flue gas fan at terminal 7 (pre- and post-purging) also receives voltage. On completion of «t16», the control command to open the air damper is given via terminal 9. During the running time of the motor, the sequence switch does not operate, as terminal 8, via which the motor of the sequence switch first receives voltage, is not under voltage during that period of time. The sequence switch starts again and programs only after the air damper is fully open and limit switch «a» has changed over to feed voltage to terminal 8.

**t1**

**Pre-purge time** with air damper fully open (nominal amount of combustion air).

Shortly after the start of the pre-purge time, the air pressure monitor «LP» must change over, thus interrupting the current path between terminal 4 and terminal 13. Otherwise, the burner control would go to lockout (start of air pressure check). At the same time, terminal 14 must be under voltage since this current path is used to power the ignition transformer and the fuel valves.

**t3'**

With the LOK16..., an ignition transformer connected to terminal 15 is therefore switched on at this moment in time (long pre-ignition). If there is no «LP», the ignition transformer receives voltage already with the start command.

On completion of the pre-purge time, the burner control via terminal 10 runs the air damper into the low-flame position, which is determined by the changeover point of auxiliary switch «m». During the positioning time, the sequence switch stops again until terminal 8 receives voltage from «m».

**t5**

**Interval.** On completion of «t5», terminal 20 receives voltage. At the same time, control outputs 9 to 11 and input 8 are galvanically separated from the unit's control section, so that the latter is protected against reverse voltages from the load control circuit.

The start-up sequence of the burner control ends with the release of load controller «LR» at terminal 20. The sequence switch switches itself automatically off, depending on the time variant used, either immediately or after some so-called «idle steps», that is, without changing the contact positions.

**Expanding flame  
burners with  
LOK16... or LGK16...**

*t3*                    **Short pre-ignition time**; then fuel release via terminal 18.

*t2*                    **Safety time** (part load)

On completion of the safety time latest, a flame signal must be present at the input of the flame signal amplifier, or else the burner control initiates lockout.

*t3n*                  **Post-ignition time** (only with the LOK16..., provided the ignition transformer is connected to terminal 15).

*t4*                    **Interval** until the fuel valve at terminal 19 is enabled.

**Interrupted pilot  
burners with LGK16...**  
(burners with pilot  
burner)

*t3*                    **Short pre-ignition time**; then release of fuel for the pilot burner via terminal 17.

*t3'*

*t2*                    **1st safety time** (pilot load)

*t2'*

No later than at the end of the safety time, a flame signal must be present at the input of the flame signal amplifier, or else the burner control initiates lockout.

*t4*                    **Interval** until the fuel valve at terminal 19 is enabled (start load of the main burner).

*t4'*

**Times «t2'», «t3'» and «t4'» are only programmed by burner controls LGK16.335 and LGK16.635.**

*t9*                    **2nd safety time.** On completion of the safety time, the main burner must have been ignited by the pilot burner, since the pilot gas valve is closed on completion of «t9».

**B**                    **Operating position of the burner**

**B-C**                  **Burner operation (generation of heat)**

During burner operation, the load controller drives the air damper to the nominal load or low-flame position, depending on heat demand. Here, the nominal load is enabled by auxiliary switch «v» in the air damper actuator.

**C**                    **Controlled shut-down by «R»**

In the case of a controlled shut-down, the fuel valves are closed immediately and, at the same time, the sequence switch starts again and programs the

*t6*                    **Post-purge time** (post-purging with fan M2 connected to terminal 7).

Shortly after the start of the post-purge time, voltage at terminal 10 is reinstated, so that the air damper is driven into the MIN position.

The full closing of the air damper starts only shortly before the completion of the post-purge time, initiated by the control signal on terminal 11, which also remains under voltage during the following burner off period.

**D-A**                  **End of control program (= start position)**

When, on completion of «t6», the sequence switch has reset the control contacts into their start positions, thereby switching itself off, the detector and flame simulation test is started again. However, during the burner off period, lockout can occur only if the faulty flame signal lasts a few seconds. Hence, short ignition pulses of the UV detector caused by cosmic radiation do not initiate lockout.

## Warning notes

- 
- To protect the burner control from electric overload, both ignition and ionization electrode must be located such that arcing over of the ignition spark to the ionization electrode cannot occur.
  - In the geographical areas where DIN standards are in use, the installation must be in compliance with VDE requirements, particularly with the standards DIN/VDE0100 and 0722!
  - Condensation and ingress of humidity must be avoided!
  - Ignition cables must always be laid separately, maintaining the greatest possible distance to the unit and other cables.
  - Observe the notes on the laying of detector cables (refer to «Technical data»!
  - The electrical wiring must be made in compliance with national and local standards and regulations!
  - LOK16... and LGK16... are safety devices. It is therefore not permitted to open, interfere with or modify the units!
  - Check wiring carefully before putting the unit into operation!
  - The unit must be completely isolated from the mains before performing any work in the electronic connection area of the LOK16... or LGK16...!
  - Check all safety functions when putting the unit into operation or after changing a fuse!
  - Ensure protection against electric shock hazard on the unit and at all electrical connections by appropriate mounting!
  - Electromagnetic emissions must be checked from an application point of view!
  - The UV detector current measuring unit KF8832 is not suited for continuous operation!
  - It is not permitted to connect two UV detectors QRA5... in parallel!
  - When using the QRA5..., earthing of terminal 22 is mandatory!
  - Supervision with detector electrode FE and UV detector QRA5... is possible, but for safety reasons, both flame detectors may not be active at the same time, with the exception of the 2nd safety time «t9». At the end of the 2nd safety time, one of the detected flames must have extinguished, e.g. by shutting down the pilot valve via terminal 17!
  - All regulations and standards applicable to the particular application must be observed!
  - Installation and commissioning work must always be carried out by qualified personnel!

## Functions

### Principle of self-checking

---

In contrast to conventional amplifiers, the signal delivered by the flame detector is handled dynamically and not statically. To achieve this, it is converted into a sequence of control pulses and is then delivered to the flame relay circuit. The latter is designed such that the flame relay can be energized only by a flame signal in the described form. If the pulses change due to a faulty detector or faulty detector cables, the relay is de-energized and the burner control initiates the required safety actions.

With UV supervision, it must also be ensured that self-ignition of the UV tube (e.g. due to ageing) does not simulate a flame signal. For this reason, the incident radiation at the UV cell is periodically interrupted by a shutter.

In addition to the self-checking facility, the flame signal circuit is subjected to a functional test during the pre-purge time. If it does not operate correctly, the start-up sequence is aborted or the burner goes to lockout.

Furthermore, if mains voltage drops to a level where the safe operation of the burner is no longer ensured, burner operation is automatically interrupted. When the mains voltage returns to the normal level, the burner control repeats the start-up sequence. However, if the detector signals are only slightly above the minimum levels, such mains voltage fluctuations may also cause burner lockout.

## Technical data

### LOK16... and LGK16...

Mains voltage	AC 220 V -15 %...AC 240 V +10 % or AC 100 V -15 %...AC 110 V +10 %	Mounting position	optional
Mains frequency	50 Hz -6 %...60 Hz +6 %	Degree of protection	IP40
Power consumption	3.5 VA	Weight	
Pre-fuse (external)	16 A max., slow	- Burner control	approx. 1000 g
Unit fuse	T6,3H250V, acc. to IEC 127	- Baseplate	approx. 165 g
Perm. input current at terminal 1	5 A, to VDE 0660 AC3	<b>Identification code to EN298</b>	<b>F B / M L L X K</b>
Perm. current load on control terminals	4 A, to VDE 0660 AC3		

#### Required switching capacity of switching devices

- between terminals 4 and 5, 4 and 12	1 A, AC 250 V
- between terminals 4 and 14	depending on load of terminals 15, 16, 18, 19 (LGK: 16...19), min. 1A, AC 250 V

#### Environmental conditions:

- Transport	IEC721-3-2 class 2K2
Climatic conditions	
Temperature	-50...+60 °C
Humidity	< 95 % r.h.
Mechanical conditions	class 2M2
- Operation	IEC721-3-3 class 3K5
Climatic conditions	
Temperature	-20...+60 °C
Humidity	< 95 % r.h.

#### CE conformance

According to the directives of the European Community	
Electromagnetic compatibility EMC	89/336 EEC incl. 92/31 EEC
Gas appliance directive	90/396 EEC
Emissions	EN 50081-1
Immunity	EN 50082-2

**Condensation, formation of ice and ingress of water are not permitted.**

## Flame supervision

	<b>RAR...</b> (LOK16...)	<b>QRA5x.C...</b> (LGK16...)	<b>QRA5x.D...</b> (LGK16...)	<b>IONIS:</b> (LGK16...)
Operating voltage (terminal 23 or 24)	< DC 1 V ±10 %	280 V <sup>1)</sup> ±10 %	280 V <sup>1)</sup> ±10 %	245 V <sup>1)</sup>
Min. detector current required	DC 6 µA	DC 35 µA <sup>2)</sup>	DC 120 µA <sup>2)</sup>	DC 12 µA
Max. possible detector current	DC 25 µA	DC 70 µA <sup>2)</sup>	DC 270 µA <sup>2)</sup>	DC 100 µA
Short-circuit current	-	-	-	approx. AC 300 µA
Max. length of detector cable (laid separately)	100 m	<sup>3)</sup>	<sup>3)</sup>	60 m <sup>4)</sup>

<sup>1)</sup> AC voltage, measured with no detector current at AC 230 V mains voltage.

Internal resistance of measuring instrument 10 MΩ. The shutter motor of the UV detector QRA5... is powered by mains voltage

<sup>2)</sup> Refer to specifications given on the KF8832 for measuring the detector current

<sup>3)</sup> • Detector cable laid in a **minimum distance of 5 cm** from other mains carrying cables:  
- As a multiple cable  
- With five single wires

**50 m max.  
70 m max.**

• With shielded three-wire control cable connected to terminals 3, 4 and 5 of the UV detector QRA5... and normal mains cable connected to terminals 1 and 2:

**15 m max.**

• With two shielded single-wire coaxial cables (≤ 45 pF/m, e.g. RG62) connected to terminals 3 and 4 of the UV detector QRA5... and normal mains cable connected to terminals 1, 2 and 5:

**60 m max.**

• If possible, the shielding should be earthed at both ends of the cable!

<sup>4)</sup> Longer cable distances are possible when connecting low capacitance detector cables to terminal 24 of the burner control (especially against earthed wires!)

## Type summary

Switching times are given in seconds, in the order of the start-up sequence, valid for a frequency of 50 Hz. At 60 Hz frequency, the times are reduced by about 20 %.

The type references are valid for burner controls operating at AC 230 V, 50...60 Hz. For burner controls operating at AC 100...110 V, 50...60 Hz, the last two digits of the type reference read ...17 in place of ...27.

LOK16...

For flame supervision with a selenium photocell detector RAR7... or RAR8... for oil burners

<b>Preferred use:</b>		Universal application	Medium or heavy oil burners
Flash-steam generators			
<b>LOK16.140A27</b>		<b>LOK16.250A27*</b>	<b>LOK16.650A27</b>
t1	10	22,5	67.5
t2	4	5	5
t2'	–	–	–
t3	2	2.5	2.5
t3'	From start command 2)		
t3n	10	15	15
t4	8	7.5	7.5
t4'	–	–	–
t5	4	7.5	7.5
t6	10	15	15
t7	2	2.5	2.5
t8	30	47.5	92.5
t9	–	–	–
t10	6	10	10
t11	Optional		
t12	Optional		
t16	4	5	5
t20	32	35	12.5
max.	1	1	1

LGK16...

For flame supervision with UV detector QRA5... or ionization current detector electrode

<b>Preferred use:</b>		D (also WLE), F	D, A	GB	F I	B NL		
Flash-steam generat.		Flash-steam generators						
<b>LGK16...</b>		<b>.122</b> A27	<b>.133</b> A27	<b>.322</b> A27*	<b>.333</b> A27*	<b>.335</b> A27*	<b>.622</b> A27	<b>.635</b> A27
t1	10	9	36	31.5	37.5	66	67.5	
t2	2	3	2	3	2.5	2	2.5	
t2'	–	–	–	–	5	–	5	
t3	4	3	4	6	5	4	5	
t3'	–	–	–	–	2.5	–	2.5	
t3n	–	–	–	–	–	–	–	
t4	6	6	10	12	12.5	10	12.5	
t4'	–	–	–	–	15	–	15	
t5	4	3	10	12	12.5	10	12.5	
t6	10	14.5	12	18	15	12	15	
t7	2	3	2	3	2.5	2	2.5	
t8	30	29	66	72	75	96	105	
t9	2	3	2	3	5	2	5	
t10	6	6	8	12	10	8	10	
t11	Optional							
t12	Optional							
t16	4	3	4	6	5	4	5	
t20	32	60	–	27	22.5	–	–	
max.	1	1	1	1	1	1	1	

## Ordering

<b>For use with oil burners</b>	Burner control without baseplate, for AC 230 V*	Control program and connection diagram like	Preferred use for/in
	<b>LOK16.140A27</b>	LAL2.14	Flash-steam generators
	<b>LOK16.250A27*</b>	LAL2.25	Universal applications
	<b>LOK16.650A27</b>	LAL2.65	Heavy oil burners
Baseplate	<b>AGM16...</b>	Coding of the baseplate allows only the use of <b>LOK16...</b> types	
Flame detectors	<b>RAR7... or RAR8...</b>	Selenium photocell detector (refer to data sheet 7713)	
<b>For use with gas, oil and dual-fuel burners (depending on type of flame detector)</b>	<b>LGK16.122A27*</b>	LFL1.122	Flash-steam generators
	<b>LGK16.133A27</b>	LFL1.133	Flash-steam generators
	<b>LGK16.322A27*</b>	LFL1.322	D (WLE), F
	<b>LGK16.333A27*</b>	LFL1.333	D, A
	<b>LGK16.335A27*</b>	LFL1.335	GB
	<b>LGK16.622A27*</b>	LFL1.622	I, F
	<b>LGK16.635A27*</b>	LFL1.635	B, NL
Baseplate	<b>AGM17...</b>	Coding of the baseplate allows only the use of <b>LGK16...</b> types	
	Detector electrode	Delivered by the burner manufacturer	
	Flame detector	Self-checking UV detector (refer to data sheet 7712)	
	Accessories for UV detector	See data sheet 7712	
	* Also available for AC 100...110 V; in that case, the last two digits of the type reference read ...17 in place of ...27		

## Fitting notes

Conversion of existing plant	When converting plants to LOK16... or LGK16..., the existing LAL or LFL baseplate must be secured by a cylinder-shaped grooved pin, thus ensuring that only one of the LOK16... or LGK16... types can be fitted. Ordering no. for grooved pin: <b>4 166 8024 0</b>
	Location of grooved pin: between terminals <b>10/11 of the LAL</b> baseplate and between terminals <b>4/5 of the LFL</b> baseplate.
Repetition in the event of loss of flame	By removing wire link B on the bottom side of the unit, the LOK16... can be switched to start repetition in the event of loss of flame during operation. For this purpose, the link must be completely cut off, but it must be made certain that this is in compliance with the local standards and regulations!

**Use of terminals  
LOK16...**

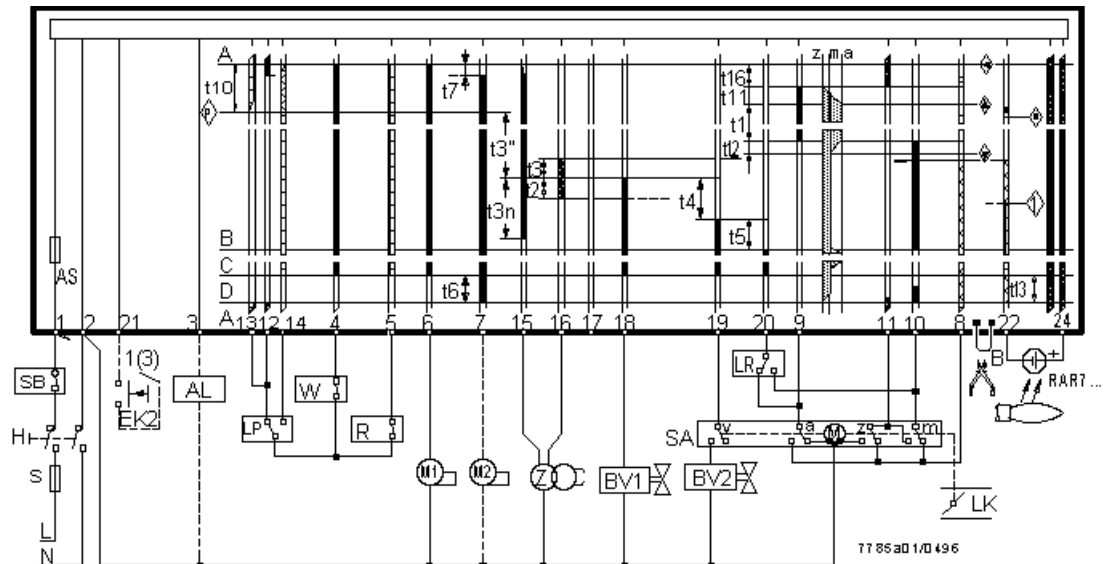

**LGK16...**

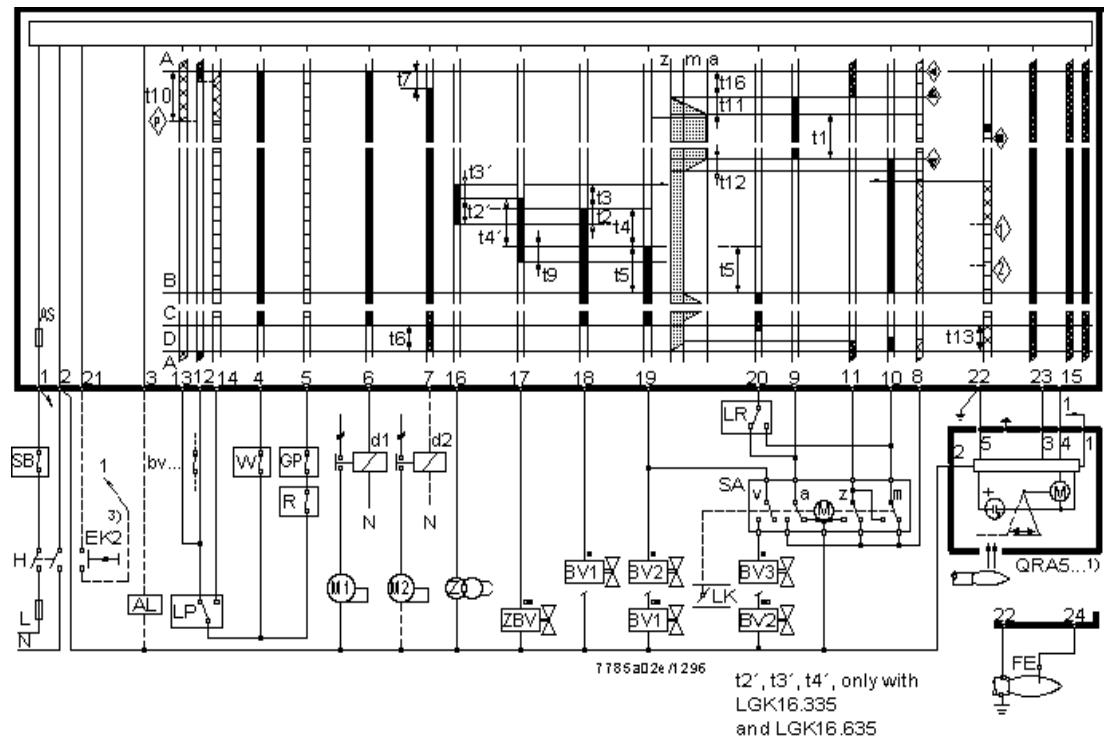

- Control signals delivered by the burner control
- Permissible input signals
- Required input signals: if these signals are not present at the points in time marked by symbols or during the shaded periods of time, the burner control interrupts the start-up sequence or initiates lockout

- Valid for expanding flame burners
- Valid for burners with a pilot burner which is shut down after the main burner has ignited

1) **When used with the QRA5..., earthing of terminal 22 is mandatory**



**Legend  
(for the entire data sheet)**

a	Changeover limit switch for air damper's OPEN position	LR	Load controller
AL	Remote lockout warning device (alarm)	m	Auxiliary changeover switch for the air damper's MIN position
AR	Main relay (load relay) with «ar» contacts	M...	Fan or burner motor
AS	Unit fuse	QRA...	UV detector
B	Wire link (on the burner control's baseplate)	R	Control thermostat or pressurestat
BR	Lockout relay with «br» contacts	RAR...	Selenium photocell detector
BV...	Fuel valve	SA	Air damper actuator
bv...	Auxiliary contact in the valve actuator for the fully closed position check	SB	Safety limit thermostat
d...	Contact or relay	SM	Synchronous motor of sequence switch
EK...	Lockout reset button	v	In the air damper actuator: auxiliary changeover switch for the release of fuel in function of the air damper position
FE	Ionization current detector electrode	V	Flame signal amplifier
FR	Flame relay with «fr» contacts	W	Limit thermostat or pressure monitor
FS	Flame signal	z	In the air damper actuator: limit switch for the air damper's CLOSED position
GP	Gas pressure monitor	Z	Ignition transformer
H	Mains isolator	ZBV	Pilot valve
L	Lockout warning lamp		
LK	Air damper		
LP	Air pressure monitor		
A	Start-up	C	Controlled shut-down
B	Operating position	D	End of control program

Lockout indication positions when there is no input signal (refer to «Control program in the event of faults»):

- ◀ No start
- ▲ Abortion of start-up sequence
- ▼ Abortion of start-up sequence
- Lockout (fault in the flame supervision circuit)
- 1 Lockout (no flame)
- 2 Lockout (no flame)
- P Lockout (no air pressure)

**Legend  
(for the times)**

t1	<b>Pre-purge time</b> with air damper fully open
t2	<b>Safety time</b> or 1st safety time with burners using a pilot burner
t2'	<b>Safety time</b> or 1st safety time with burners using a pilot burner
t3	<b>Pre-ignition time</b>
t3'	<b>Pre-ignition time</b>
t3n	<b>Post-ignition time</b> (ignition transformer connected to terminal 15)
t4	<b>Interval</b> from the start of «t2» or «t2'» to the release of the valve connected to terminal 19
t4'	<b>Interval</b> from the start of «t2» or «t2'» to the release of the valve connected to terminal 19
t5	<b>Interval</b> from the end of «t4» or «t4'» to the release of the load controller or valve at terminal 20
t6	<b>Post-purge time</b> (identical with the permissible after-burn time «t13»)
t7	<b>Switch-on delay for fan motor M2</b>
t8	<b>Duration of start-up sequence</b> excluding «t11» and «t12»
t9	<b>2nd safety time</b> with burners using a pilot burner
t10	<b>Interval</b> from the start to the beginning of the air pressure check
t11	<b>Running time</b> of air damper into OPEN position
t12	<b>Running time</b> of air damper into low-flame position
t13	<b>Permissible after-burn time</b>
t16	<b>Interval</b> from the start to the OPEN command for the air damper
t20	<b>Interval</b> to the self-shutdown of the sequence switch
max.	<b>Safety time in the event of loss of flame</b> during operation

Only burner controls LGK16.335... and LGK16.635... program the times «t2'», «t3'» and «t4'».

# Connection diagrams

LGK16...

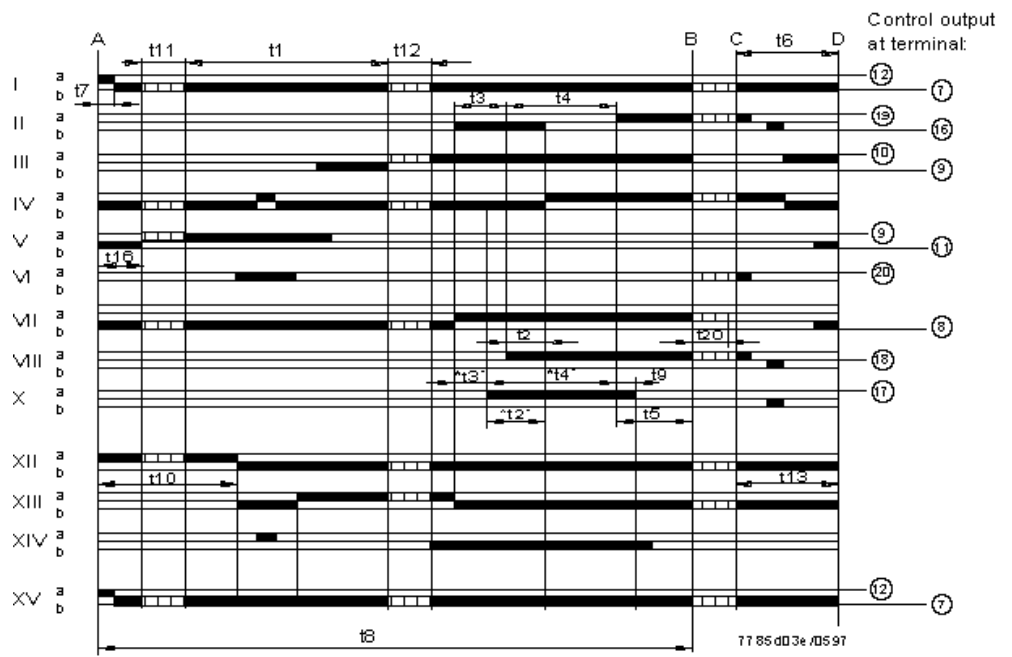
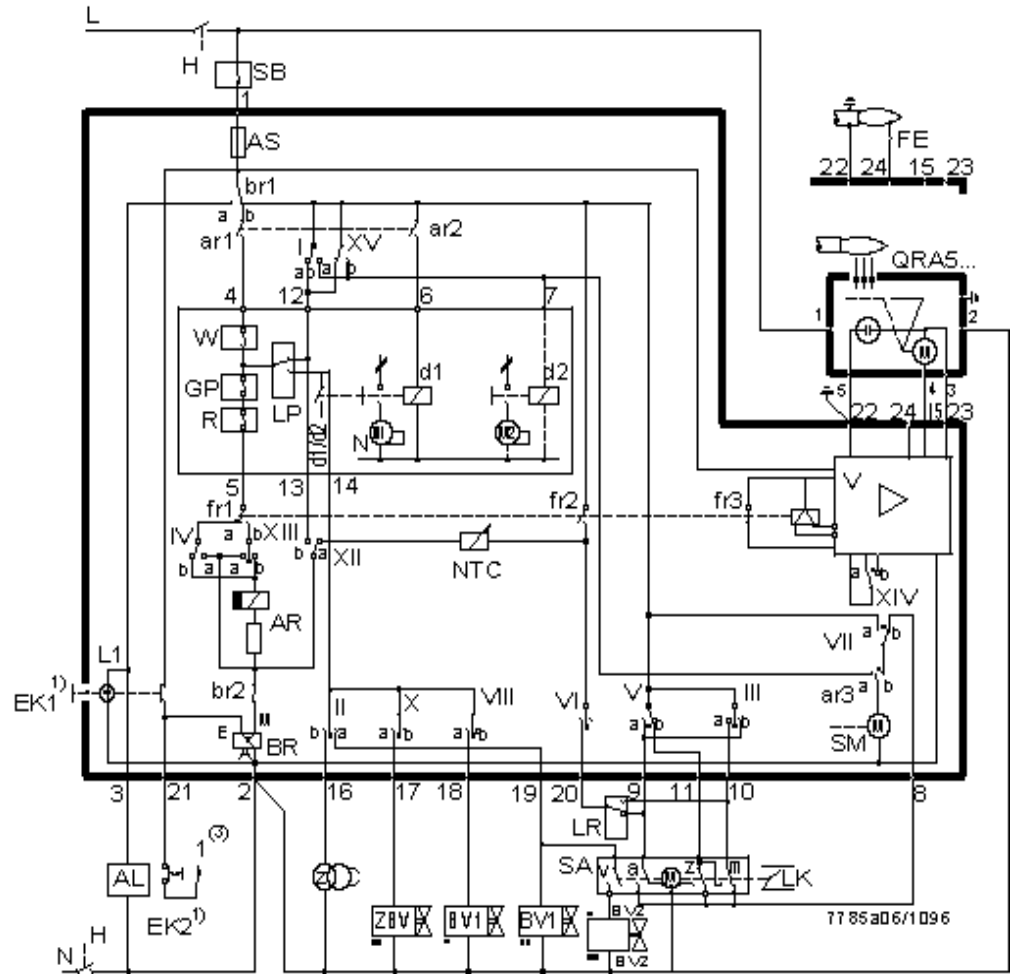

- Valid for expanding flame burners
  - Valid for interrupted pilot burners (burners with a pilot burner)
- 1) **Do not press EK for more than 10 seconds**

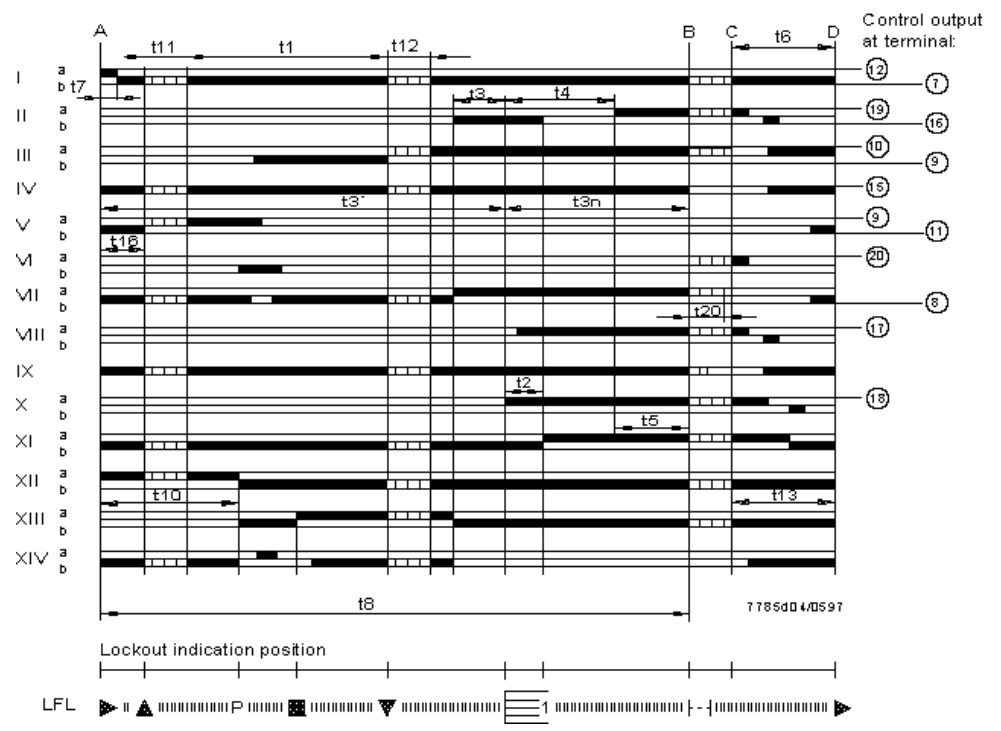
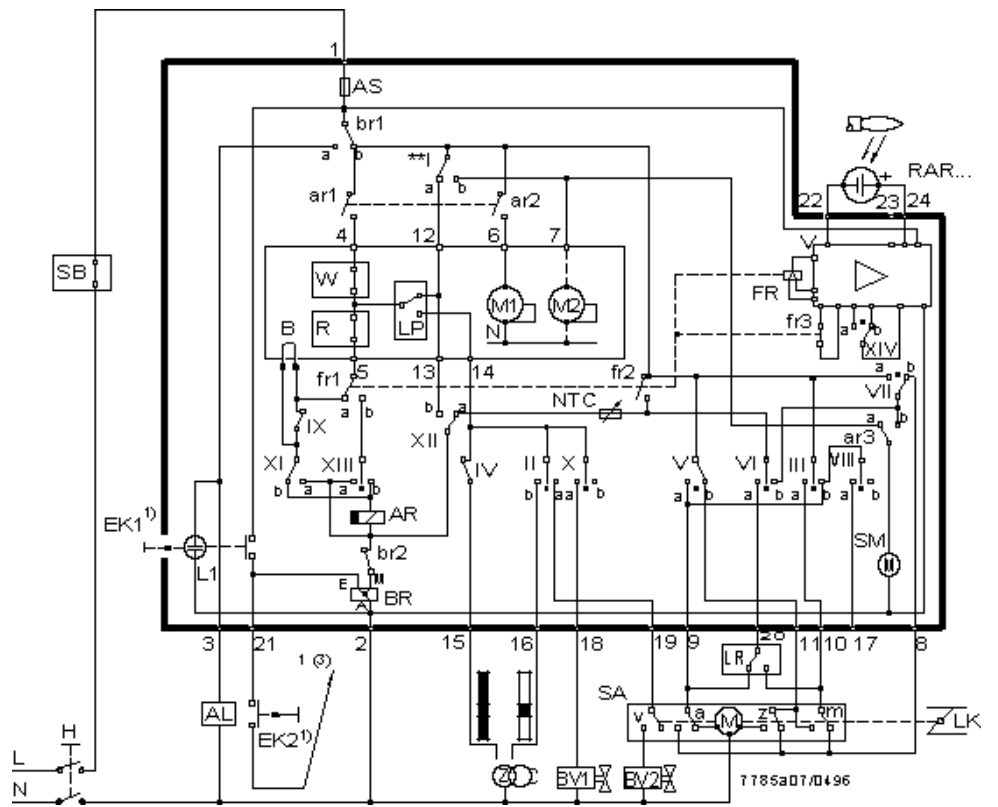

## Control program under fault conditions

---

In case of any disturbance, the supply of fuel is immediately interrupted. At the same time, the sequence switch stops and thus the lockout indicator, too. The symbol appearing above the reading mark indicates the kind of fault:

- ◀ **No start**, because one of the contacts is not closed (also refer to «Prerequisites for burner start-up») or **lockout during or after completion of the control program** due to extraneous light (e.g. flame not extinguished, leaking fuel valves, faulty flame supervision circuit, or similar).
- ▲ **Abortion of start-up sequence**, because limit switch «a» has not fed the OPEN signal to terminal 8. Terminals 6, 7 and 14 and, in case LOK16... is used, terminal 15, also remain under voltage until the fault is corrected.
- P **Lockout**, because the air pressure signal has not been received at the start of the air pressure check.  
**Any air pressure failure after this point in time also causes burner lockout!**
- **Lockout** due to a fault in the flame supervision circuit.
- ▼ **Abortion of start-up sequence**, because auxiliary switch «m» has not delivered the positioning signal for the low-flame position to terminal 8. Terminals 6, 7 and 14 and, in case LOK16... is used, terminal 15, also remain under voltage until the fault is corrected.
- 1 **Lockout**, because no flame signal has been received on completion of the (1st) safety time.
- 2 Only with the LGK16...:  
**Lockout**, because no flame signal has been received on completion of the 2nd safety time (flame signal of the main flame with interrupted pilot burners).
- | **Lockout \*)**, because the flame signal has been lost during burner operation or air pressure failure has occurred.

\*) LOK16...

If wire link «B» has been cut off and the flame is lost during burner operation, the burner control programs a repetition of the start-up sequence with the full program.

## Lockout indication

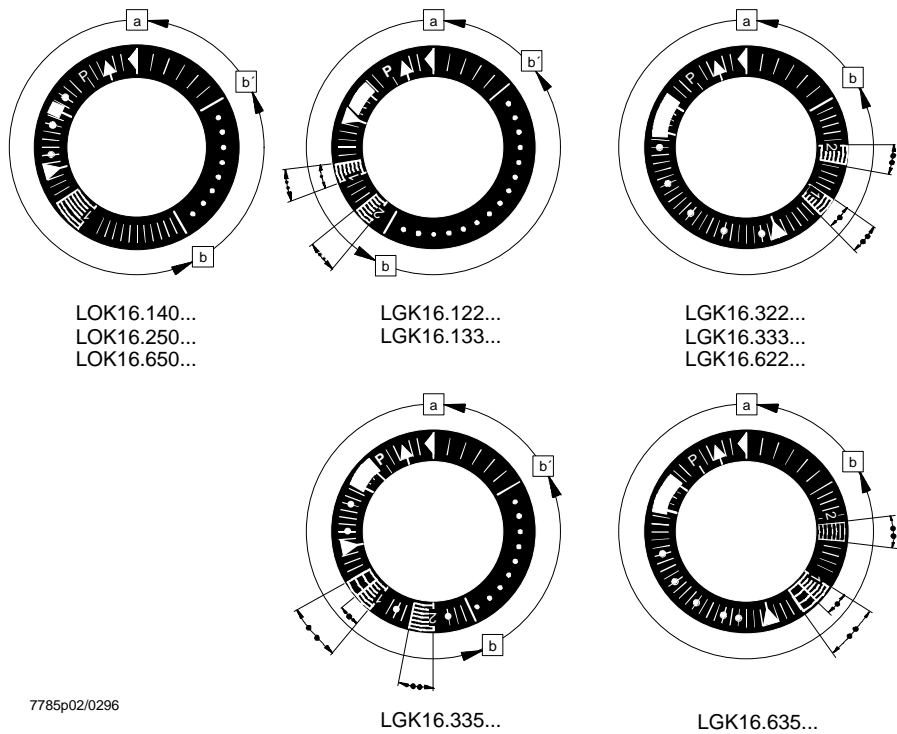

**a-b** Start-up sequence

**b-b'** With some time variants: «idle steps» of the sequence switch up to the self-shutdown after burner start-up

(b' = operating position of sequence switch)

**b(b')-a** Post-purge sequence after the controlled shut-down. In start position «a», the sequence switch switches itself automatically off or immediately initiates another burner start-up (e.g. after a fault has been corrected)

- Duration of safety time with expanding flame burners
- Duration of safety times with interrupted pilot burners

When lockout has occurred, the burner control can immediately be reset. After resetting, and also after correction of a fault which resulted in a shut-down, or after a mains failure, the sequence switch always runs into its start position, whereby **only** terminals 7, 9, 10 and 11 receive voltage in accordance with the control program. It is only then that the burner control programs a restart of the burner.

**Note: do not press the reset button for more than 10 seconds.**

## Connection examples

LGK16...

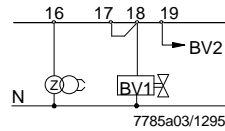

### Doubling of safety time with expanding flame burners

when using burner control LGK16.335 or LGK16.635.

By connecting terminals 17 and 18, the safety time is doubled and the pre-ignition time is reduced by 50 %. **Before using this circuit, it must be ensured that the longer safety time is in compliance with national standards and regulations!**

LOK16...

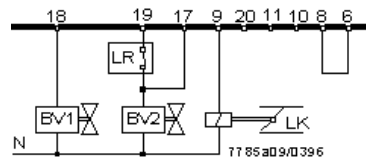

### Control of the air damper actuator during operation by feeding control signals to terminal 17

### Wiring required for operation without air pressure supervision

If an auxiliary contact of the fan contactor is included in the circuit as shown in the diagram, ignition and fuel release are possible only when the contact is closed.

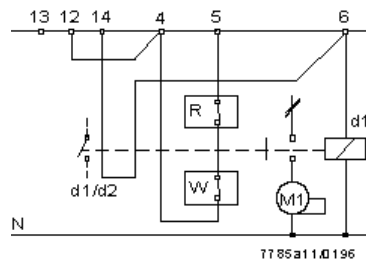

LOK16.../LGK16...

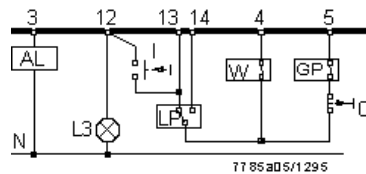

### Semi-automatic start-up

The burner is switched on manually by pressing button «I». Then, the burner control programs the start-up sequence and flame supervision.

The burner is switched off manually by pressing button «0», or automatically by the limit thermostat or pressure monitor «W», or the gas pressure monitor «GP». «L3» indicates when the burner control is ready to be started; it extinguishes shortly after the burner is switched on.

For the other connections, refer to the connection diagrams.

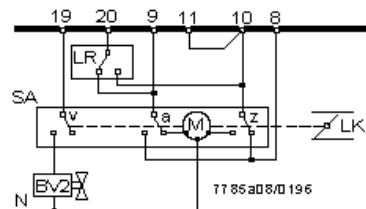

### Connection of air damper actuators without changeover limit switch for the CLOSED position

«Z» is set to low-flame

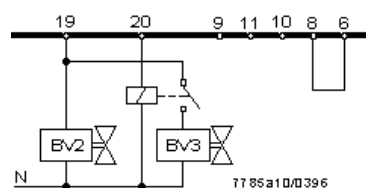

### Control of a fuel valve by terminal 20 in the case of burners without air damper or with an air damper not controlled by the burner control

The relay is not required if the valve connected to terminal 20 is **hydraulically series-connected** to a valve controlled by terminal 18 or 19. If no air damper actuator is used, terminal 8 must be connected to terminal 6.

## Measuring the detector current

LOK16.../RAR...

The measuring instrument must be connected between the detector and terminal 22 (+pole to terminal 22).

LGK16.../QRA5...

Use the **KF8832** measuring instrument (not suited for continuous operation!).  
There is **no** self-checking while measurements are made.  
The KF8832 is not required when using the **QRA5x.D...**

LGK16.../FE

The measuring instrument must be connected between terminal 24 and the detector electrode (+pole to terminal 24).

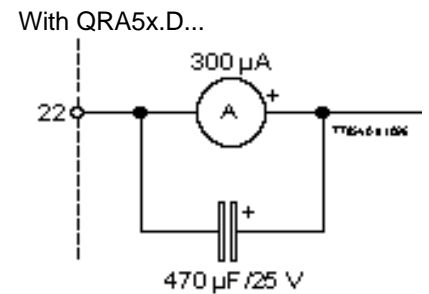
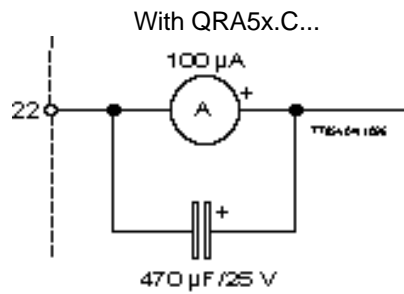
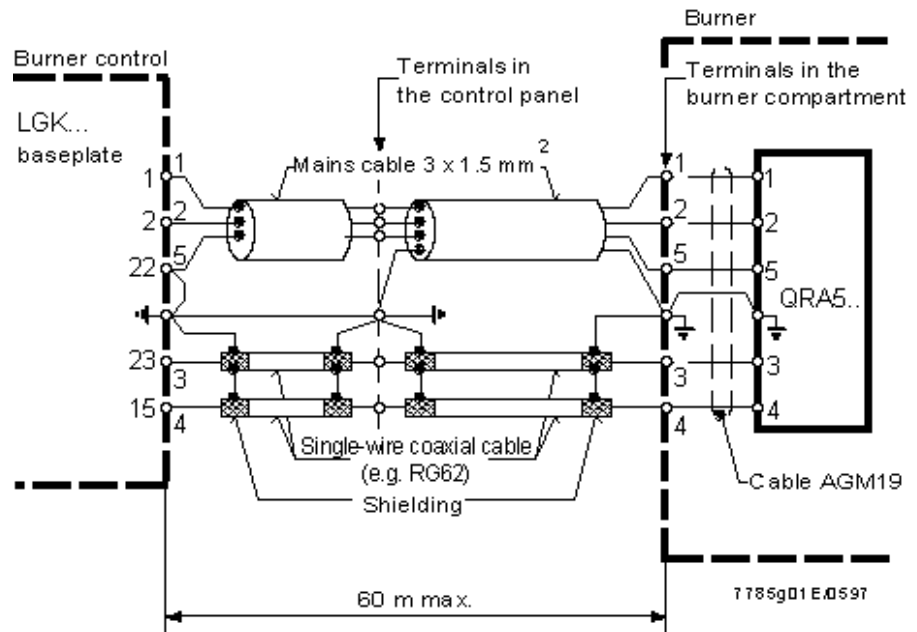

With RAR...

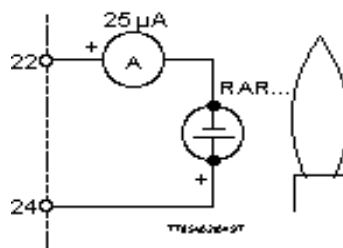

With ionization

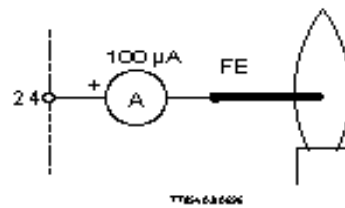

## Sequence diagrams

**Expanding flame burners** (burners without a pilot burner), controlled and supervised by LOK16... or LGK16...

Air damper in low-flame position during burner off times (min.).

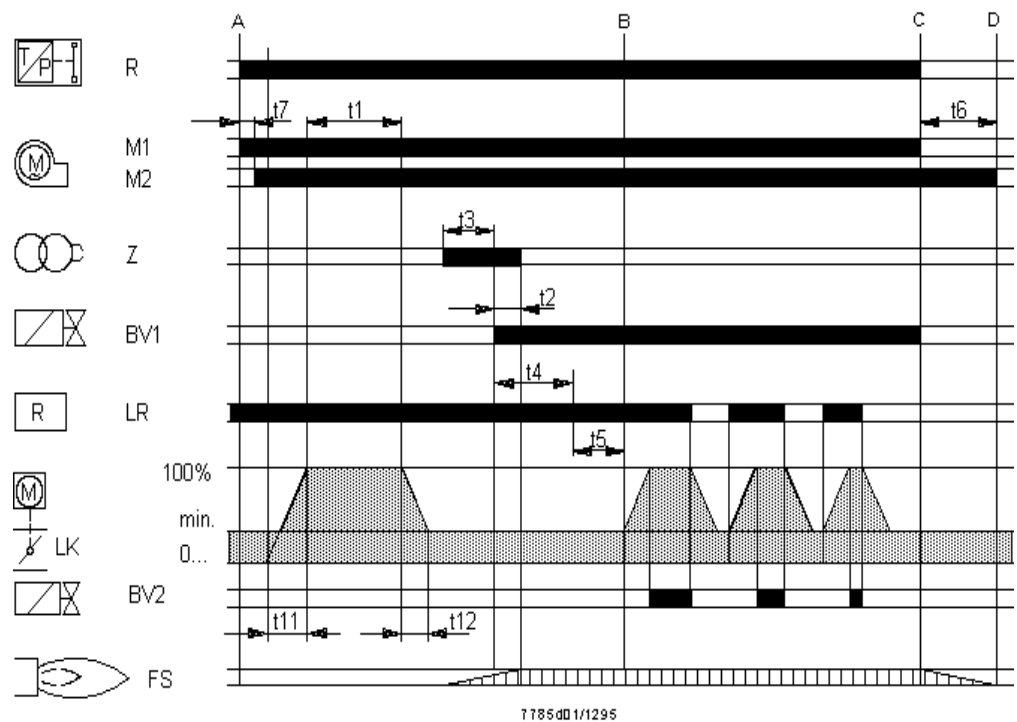

**Interrupted pilot burners** (burners with a pilot burner), controlled and supervised by LGK16.335 or LGK16.635, for example. The other types of burner controls of the LGK16... range program the times «t2», «t3», «t4» and «t9» for the pilot burner.

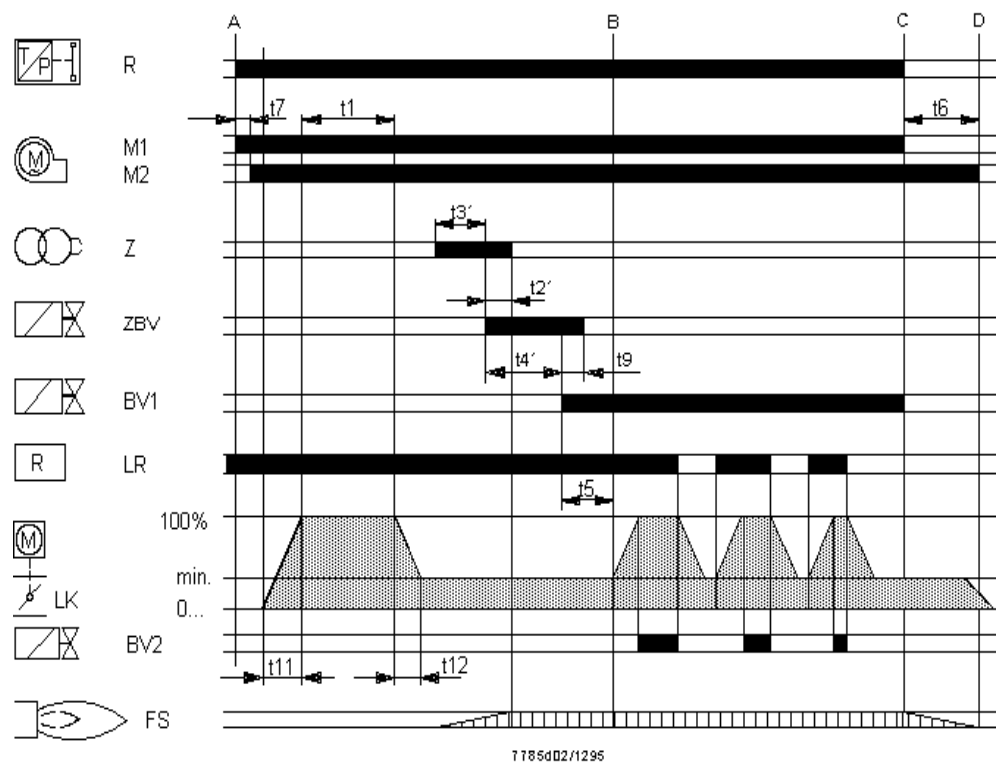



# Dimensions

Dimensions in mm

**LOK16... with baseplate AGM16...**

**LGK16... with baseplate AGM17...**

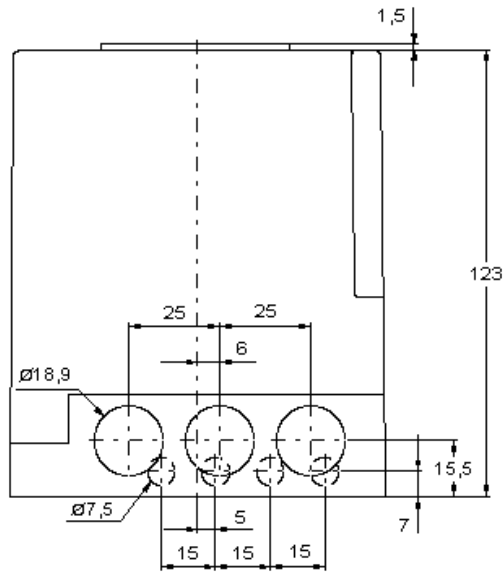

**AGM16..., AGM17...**

